

# ALUMINUM

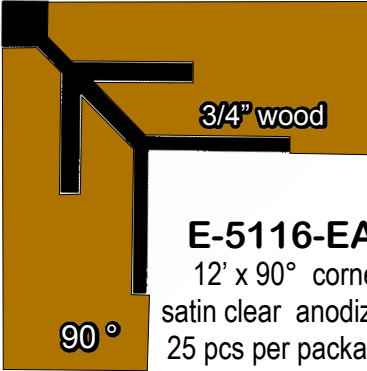

# Display Fixture

(763) 493-2995



**E-5116-EA**  
12' x 90° corner  
satin clear anodized  
25 pcs per package.

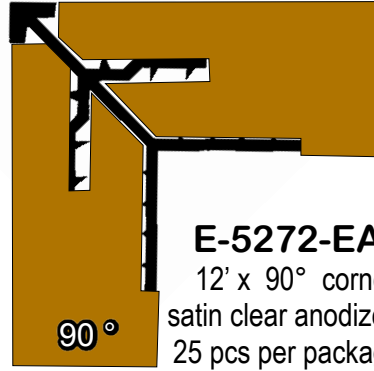

**E-5272-EA**  
12' x 90° corner  
satin clear anodized.  
25 pcs per package.

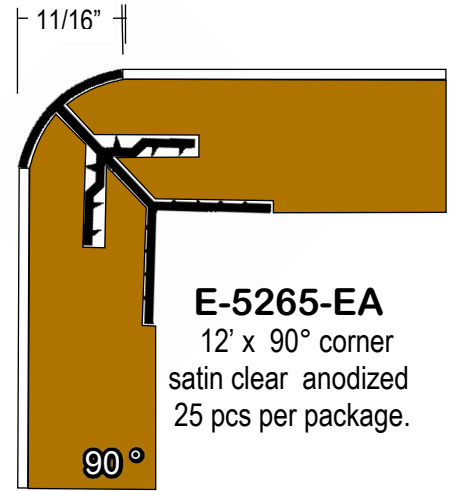

**E-5265-EA**  
12' x 90° corner  
satin clear anodized  
25 pcs per package.

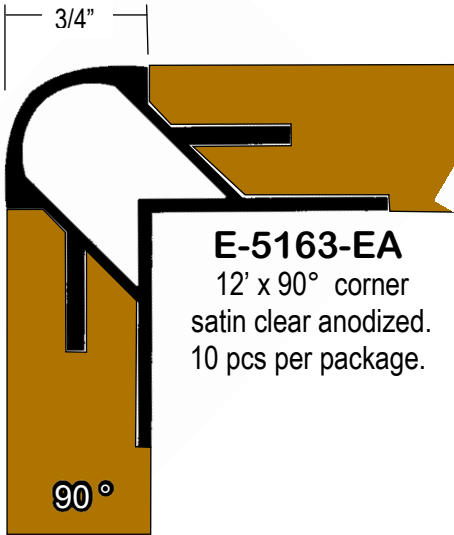

**E-5163-EA**  
12' x 90° corner  
satin clear anodized.  
10 pcs per package.

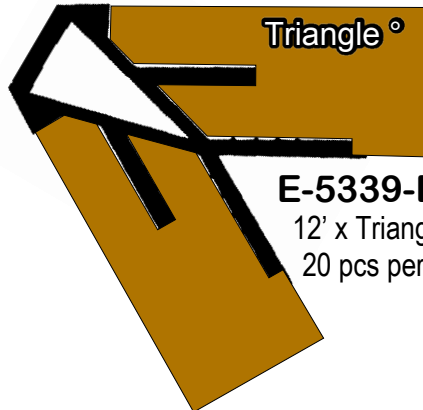

**E-5339-EA**  
12' x Triangle corner  
20 pcs per package.

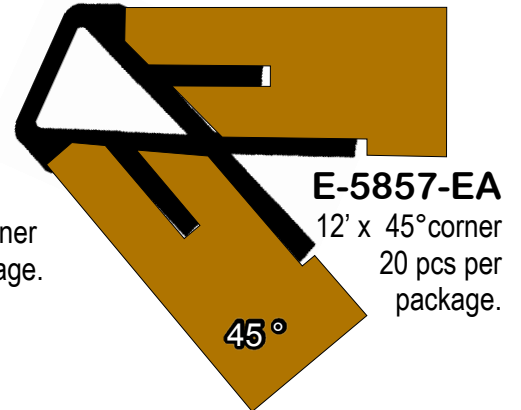

**E-5857-EA**  
12' x 45° corner  
20 pcs per package.

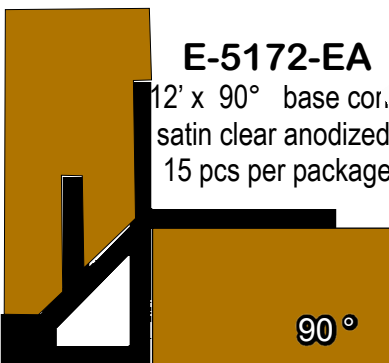

**E-5172-EA**  
12' x 90° base cor.  
satin clear anodized.  
15 pcs per package.

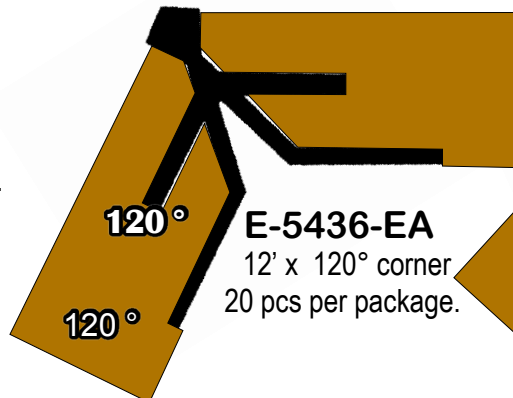

**E-5436-EA**  
12' x 120° corner  
20 pcs per package.

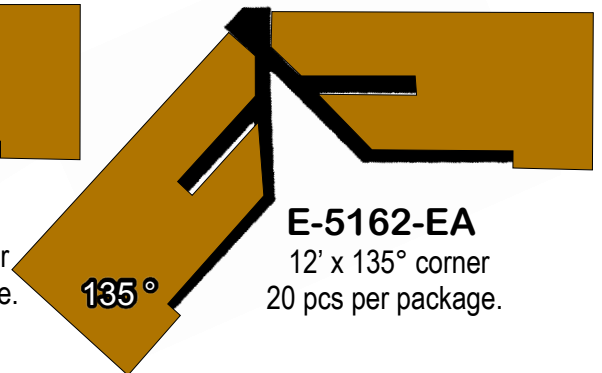

**E-5162-EA**  
12' x 135° corner  
20 pcs per package.

# ALUMINUM



# Display Fixture

 (763) 493-2995



**E-5164-EA**  
12' shelf support  
50 pcs per package.



**E-5165-EA**  
12' shelf face cap  
50 pcs per package.

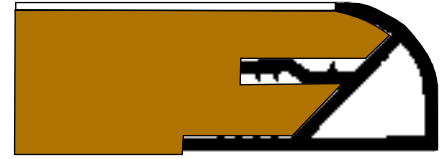

**E-5293-EA**  
12' radius end cap  
40 pcs per package.

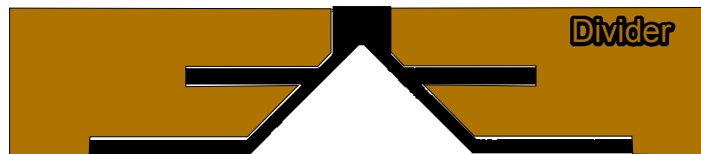

**E-5393-EA**  
12' joint divider fastener  
15 pcs per package.

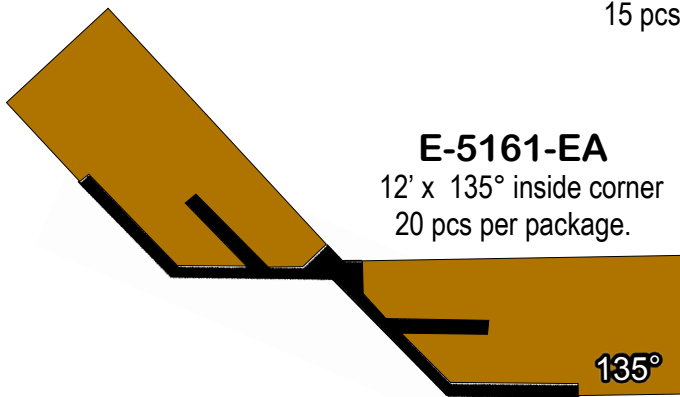

**E-5161-EA**  
12' x 135° inside corner  
20 pcs per package.

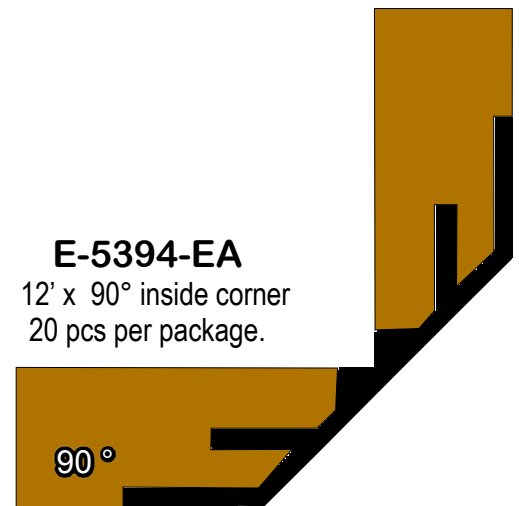

**E-5394-EA**  
12' x 90° inside corner  
20 pcs per package.

## 5 Piece Cutter Head Assembly

Wt 5 lbs per unit

1 interchangeable cutter  
For 1/2" radius included

Bushings available for this  
Set 1" & 1-1/8"

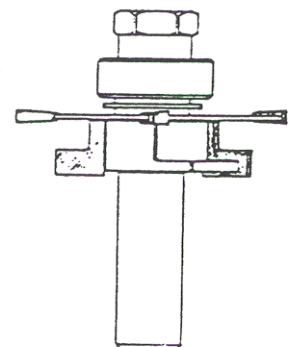
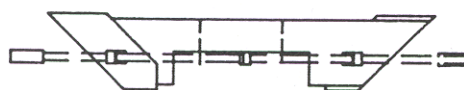
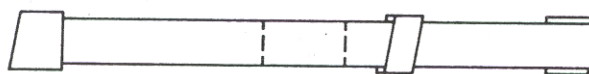

Light weight cap  
cutter head